

Instruction  
Hardware Engineering

No. LMS 11-19

Subject: Flat Braid Cables

APPROVED BY: Manager, Hardware Engineering

STATUS: Maintenance Revision

PURPOSE: Establishes the requirements for the fabrication of special-purpose electrical cable utilizing flat braid and insulation sleeving (zipper tubing). Requirements of this instruction shall be followed by L-3 Communications Corporation, Link Simulation & Training Division (hereafter referred to as Link) personnel when fabricating flat braid cables.

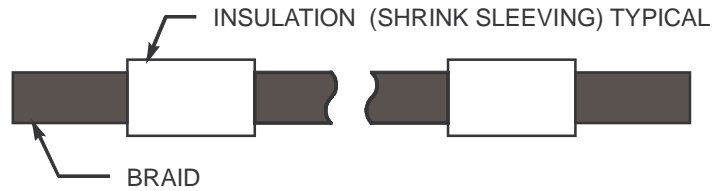
AFFECTED FUNCTIONS: Hardware Engineering  
Manufacturing

REFERENCES: **LMS 11-8** Wire Identification and Sleeving  
**LMS 11-9** Solderless (Crimp-Type) Terminations

DEFINITIONS: None

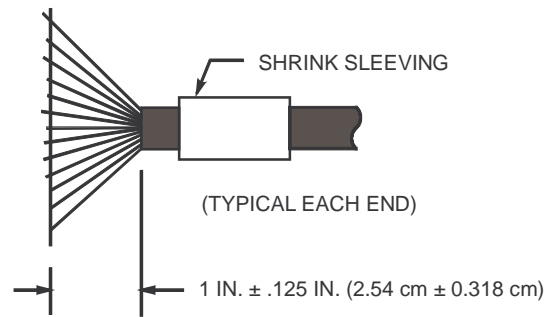
## INSTRUCTION

1. Requirements
  - 1.1 Flat braided copper wire cables shall have lugs crimped in accordance with **LMS 11-9**. The engineering drawing shall specify all necessary parts and materials.
  - 1.2 Preliminary procedures. When specified on the engineering drawing, clear insulation shall be applied as defined in paragraph 1.8.
    - a. Cut two pieces of insulation (shrink sleeving) approximately 4 inches (10.16 cm) each and slip over each end of the braid. (See Figure 1.)
    - b. Comb out the braid and cut strands to dimension as shown in Figure 2.
    - c. Terminate braid ends as specified on the assembly drawing and as outlined in paragraph 1.3, 1.4 or 1.5.



00110801

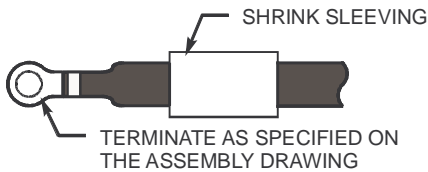
**Figure 1 Applying Shrink Sleeving**



00110802

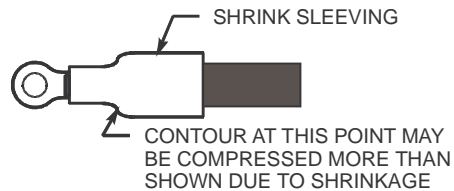
**Figure 2 Combing and Cutting the Braid**

- 1.3 Procedure for terminating braid with one terminal lug.
- Twist the strands into a circular shape and trim all strands evenly.
  - Insert twisted strands into terminal lug and crimp. (See Figure 3.)
  - Slide the insulation over the barrel of the terminal lug and shrink into position. (See Figure 4.)



00110803

**Figure 3 Terminating Braid with One Lug**



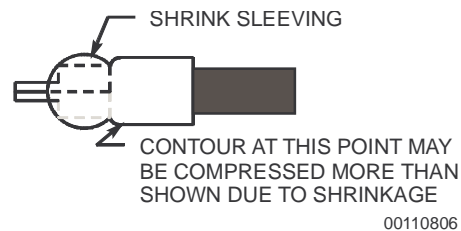
00110804

**Figure 4 Sleeving on Braid with One Lug**

- d. Complete the assembly by applying the insulation wrap and marker tape as outlined in paragraphs 1.6 and 1.7.
- 1.4 Procedure for terminating braid with two terminal lugs.
- a. Divide the braid strands into two equal parts. Twist each part into a circular shape and trim all strands evenly.
  - b. Insert each part of the braid into a terminal lug so that the terminal lugs are back-to-back and crimp as shown in Figure 5.
  - c. Position the terminal lugs together, slide the insulation over the barrel of the terminal lugs, and shrink. (See Figure 6.)

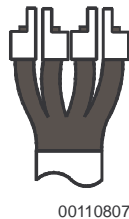


**Figure 5 Terminating Braid with Two Lugs**



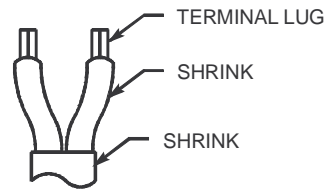
**Figure 6 Sleeving on Braid with Two Lugs**

- d. Complete the assembly by applying the insulation wrap and marker tape as outlined in paragraphs 1.6 and 1.7.
- 1.5 Procedure for terminating braid with four terminal lugs.
- a. Divide the braid into four equal parts. Twist each part of the braid into a circular shape and trim all strands evenly.
  - b. Insert each part of the braid into a terminal lug so that two of the terminal lugs are back-to-back and crimp each lug as shown in Figure 7. Repeat with the remaining two terminal lugs.
  - c. Slide an additional piece of shrink insulation over each pair of terminal lugs and shrink into position as shown in Figure 8.



00110807

**Figure 7 Terminating Braid with Four Lugs**



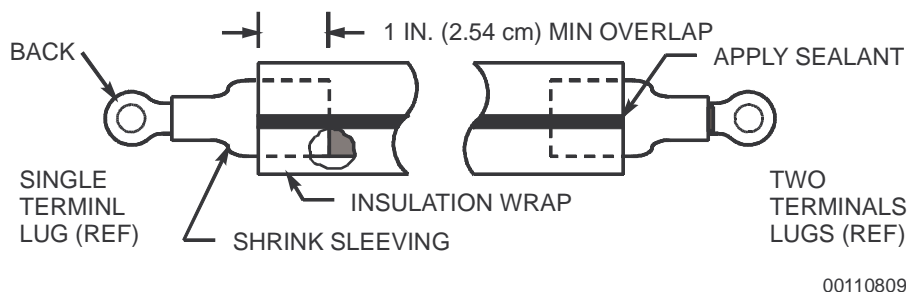
00110808

**Figure 8 Sleeving on Braid with Four Lugs**

- d. Complete the assembly by applying the insulation wrap and marker type as outlined in paragraphs 1.6 and 1.7.

1.6 Application of insulation wrap.

- a. Apply the insulation wrap so that it overlaps the shrink sleeving as shown in Figure 9. For single terminal lugs, the seam of the insulation wrap shall be located at the back of each lug.
- b. Apply sealant along entire seam. (See Figure 9.)



00110809

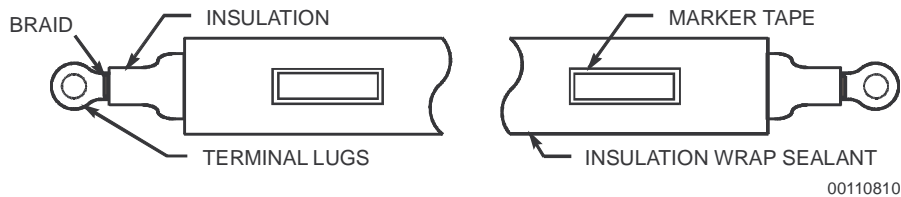
**Figure 9 Applying Insulation Wrap to Braid**

- c. Lace the insulation wrap as necessary.

1.7 Preparation and application of marker tape.

- a. Prepare markings as described in **LMS 11-8**.

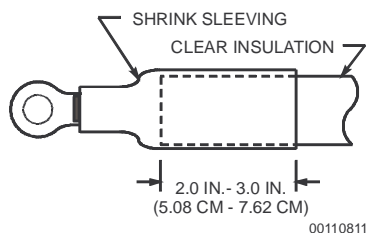
- b. Position the marked area on the insulation wrap so that it is on the opposite side of the seam and located where the insulation wrap presents a good flat surface, not distorted by the shrink sleeving (peel backing from tape before applying). Press the marker tape firmly to insure good adhesion.
- c. Apply a clear portion of the tape directly over the marked portion and press firmly in place. See Figure 10 for complete assembly.



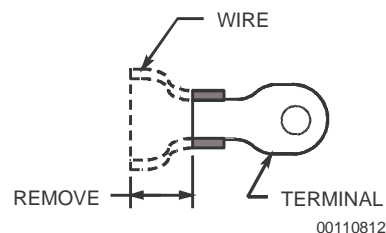
**Figure 10 Application of Marker Tape to Braid**

1.8 Application of clear insulation.

- a. Clear insulation, when used on flat braid cables, shall be overlapped by the heat shrink sleeving as shown in Figure 11. The clear insulation shall not be tied under the shrink sleeving. An overlap of 2 to 3 inches (5.08 cm to 7.62 cm) shall be provided.
- b. On those types of terminal lugs having a large diameter wire insulation support and where the insulation support prohibits installation of the insulation over the cable, it is permissible to alter the terminal lug by cutting off the insulation support approximately flush with the end of the lug. (See Figure 12.)



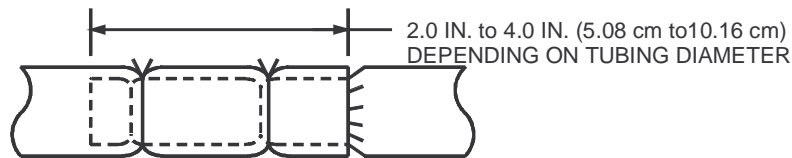
**Figure 11 Braid with  
Clear Insulation**



**Figure 12 Modification of  
Large Terminal Lugs**

- c. Clear sleeving may be spliced by closing and spot tying the end of one of the tubing sections in two places, inserting it into the second section, closing the second section, and spot tying in two places as shown in Figure 13. The maximum number of splices in a cable or harness assembly is shown below.

CABLE LENGTH	MAX NO. OF SPLICES
Less Than 10 ft. (3.048 m)	0
10 ft. to 25 ft. (3.048 m to 7.62 m)	1
Over 25 ft. (7.62 m)	2



00110813

**Figure 13 Splicing Clear Sleeving**

2. Quality Assurance Provisions
  - 2.1 The Quality Assurance Organization shall be responsible for assuring that all requirements of this instruction are met.
3. Preparation For Delivery (Not Applicable)
4. Notes
  - 4.1 This instruction supersedes Link drawings 666493 and 971052.